

SPECIFICATION FOR APPROVAL

承 认 书

CUSTOMER'S CODE

客户代码: _____

DESCRIPTION

品 名: _____ 发光二极管

SPECIFICATION

规 格: _____ Φ 3 红蓝双色 雾状 共阳

DATE

送样日期: _____

PART NO.

本厂型号: _____ 30CYS-RBW-阳

REFERENCE No.

档案号: _____

NUMBER OF SAMPLE

送样数量 _____

COPY OF ACKNOWLEDGEMENT

承认书份数 _____

Approved By Customer 客 户 承 认	Qualified By 核 准	Form Designer 制 作

Emitter 外型图:

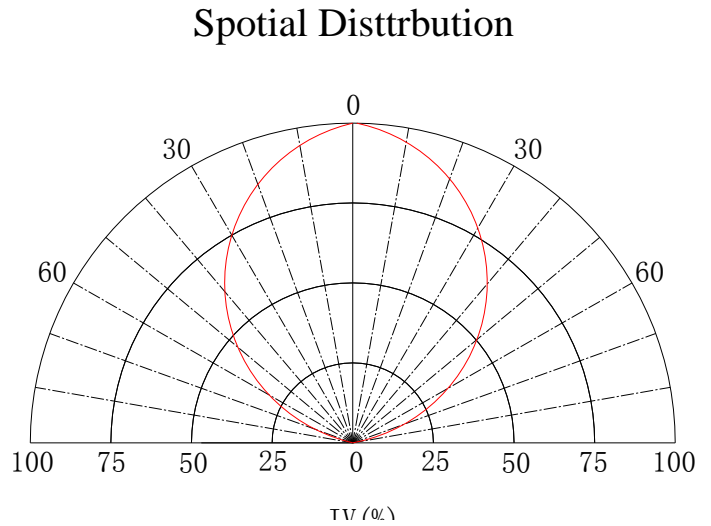
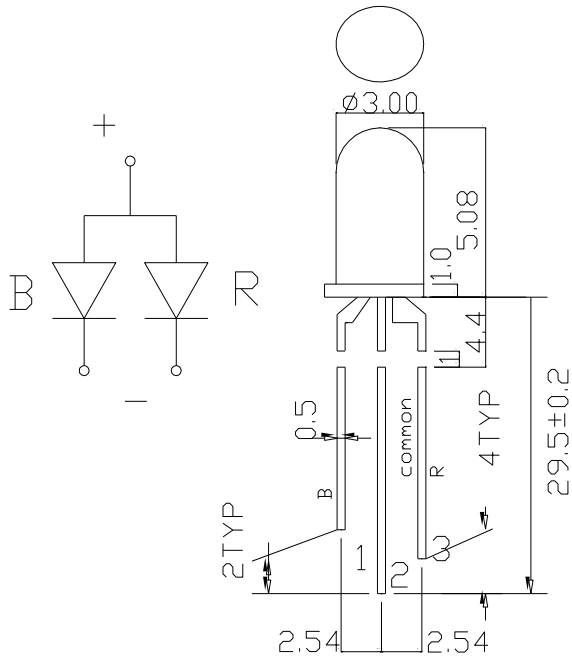

Typical electrical-optical Characteristics curves

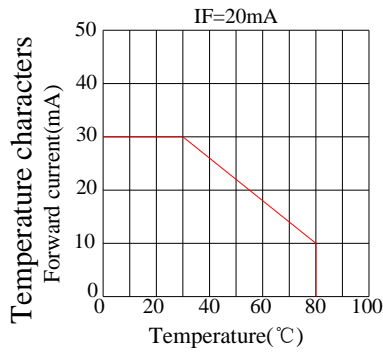
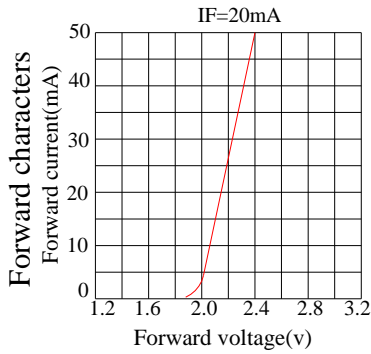

Notes:

The data are an typical presentation of the product, Contact customer service for details of technical information and warranty. The product is sensitive to static antistatic operation environment is recommended Products are shipped in either bulk bag package or taping.

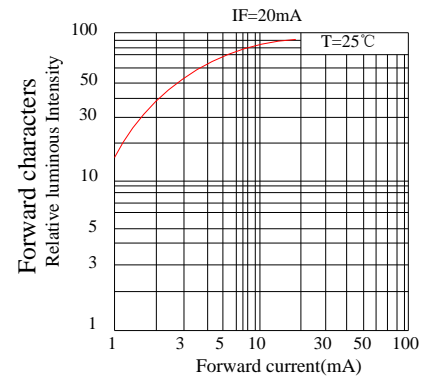
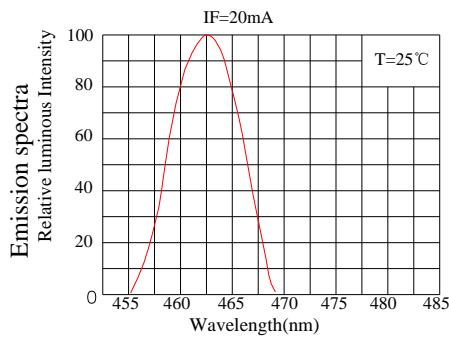
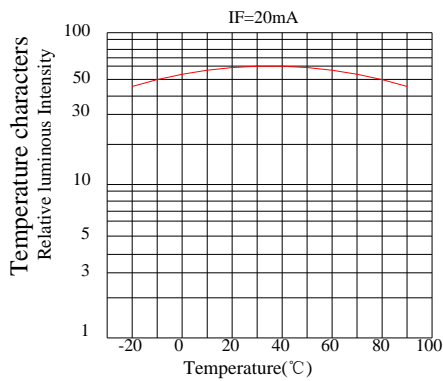

■ Absolute Maximum Rating 极限工作参数

Item 项目	Symbol 代号	Absolute Maximum Rating 极限工作参数	Unit 单位
Forward Current 正向电流	IF	20	mA
Peak Forward Current 瞬间脉冲电流	IFP	50	mA
Reverse Voltage 反向电压	VR	5	V
Power Dissipation 消耗功率	PD	100	mw
Electrostatic discharge 静电释放	ESD	1000	V
Operation Temperature 工作温度范围	TOPR	-25~+80	°C
Storage Temperature 存放温度范围	TSTG	-40~+80	°C
Lead Soldering Temperature 最高焊接温度	TSOL	330 °C for 3sec Max。	

*Ifp Conditions: Pulse Wide ≤ 10msec ≤ 1/10

瞬间脉冲电流

*Tsol Conditions: 3mm from the base of epoxy bulb 最高焊接温度 距胶体 3mm

■ Typical Optical/Electrical Characteristics 光电特性参数

Item 项目	Symbol 代号	Condition 测试条件	测试条	Min 最小值	Typ 典型值	Max 最大值	Unit 单位
Forward Voltage 正向电压	VF	IF=20mA	R	1.8	2.0	2.2	V
			B	3.0	3.2	3.4	
Light intensity 光强度	IV	IF=20mA	R	300	350	400	mcd
			B	500	600	700	
Wavelength 波长	WD	IF=20mA	R	620	623	625	nm
			B	465	468	470	
Reverse current 逆向电流	IR	IF=20mA		0	/	10	uA
Viewing Angle 半光全角	2θ 1/2	IF=20mA				30	deg
Recommend Forward Current 持续正向电流	IF(rec)	IF=20mA				20	mA

Notes:

1. Work absolute ratings $T_a=25^{\circ}\text{C}$ 工作常规值 温度=25 $^{\circ}\text{C}$

2. Tolerance of measurement of forward voltage $\pm 0.1\text{V}$ 正向电压误差范围 $\pm 0.1\text{V}$

LED LAMP RELIABILITY

● Test Items And Results

Type	Test Item	REF. Standard	Test Condition	Note	Number of Damaged
Environmental Sequence	Temperature Cycle	JIS C 7021 (1997) A-4	$-20^{\circ}\text{C} \rightarrow 25^{\circ}\text{C} \rightarrow 80^{\circ}\text{C} \rightarrow 25^{\circ}\text{C}$ 30mins,5mins,30mins,5mins	100 cycles	0/100
	High Humidity Heat Cycle	JIS C 7021 (1997) A-5	$30^{\circ}\text{C} \rightarrow 65^{\circ}\text{C}$ 90%RH 24hrs/1cycle	10 cycles	0/100
	High Temperature Storage	JIS C 7021 (1997) B-10	$T_a=80^{\circ}\text{C}$	1000hrs	0/100
	Humidity Heat Storage	JIS C 7021 (1997) B-11	$T_a=60^{\circ}\text{C}$ RH=90%	1000hrs	0/100
	Low Temperature Storage	JIS C 7021 (1997) B-12	$T_a= -30^{\circ}\text{C}$	1000hrs	0/100
Operation Sequence	Life Test	JIS C 7035 (1985)	$T_a=25^{\circ}\text{C}$ $I_F=20\text{mA}$	1000hrs	0/100
	High Humidity Heat Life Test	*	60°C RH=90% $I_F=20\text{mA}$	500hrs	0/100
	Low Temperature Life Test	*	$T_a= -20^{\circ}\text{C}$ $I_F=20\text{mA}$	1000hrs	0/100
Destructive Sequence	Resistance to Soldering Heat	JIS C 7021 (1997) A-11	$T_{\text{sol}}=260 \pm 5^{\circ}\text{C}$,10sec (3mm from the base of the epoxy bulb)	1 time	0/20
	Solderability	JIS C 7021 (1997) A-2	$T_{\text{sol}}=235 \pm 5^{\circ}\text{C}$,5sec (Using flux)	1 time (over 95%)	0/20
	Lead Pull/Bend Test	JIS C 7021 (1997)A-11	Load 2.5N (0.25kgf) $0^{\circ} \rightarrow 90^{\circ} \rightarrow 0^{\circ}$ Bending 3 times	No noticeable damage	0/20

* Refer to reliability test standard specification for in this line.

● Criteria for Judging The Damage

Item	Symbol	Test Condition	Criteria for Judgment	
			Min.	Max.
Forward Voltage	V_F	$I_F = 20\text{mA}$	---	Initial data x 1.1
Reverse Current	I_R	$V_R = 5\text{V}$	---	Initial data x 2.0
Luminous Intensity	I_v	$I_F = 20\text{mA}$	Initial data x 0.7	---